



4

LANGPRODUKTE

klöckner & co
Deutschland



Ihr zuverlässiger Partner

5

BREITFLANSCHTRÄGER/FORMSTAHL	6
STABSTAHL	8
SPEZIALPROFILE, WARMGEWALZT	14
SPEZIALPROFILE, KALTPROFILIERT	18
ANSCHLAGPROFILE	26
SYSTEME	28



6 FORMSTAHL

SCHMALER I-TRÄGER, GENEIGTE INNERE FLANSCHFLÄCHEN

Formstahl warmgewalzt S 235 JR, in HL

Dimensionen	kg/m	Dimensionen	kg/m
IPN100	8,5	IPN220	31,7
IPN140	14,6	IPN240	36,9
IPN140	14,6	IPN260	42,7
IPN180	22,3	IPN280	48,8
IPN200	26,7	IPN300	55,2

MITTELBREITER I-TRÄGER, PARALLELE INNERE FLANSCHFLÄCHEN

Formstahl warmgewalzt S 235 JR, in HL

Dimensionen	kg/m	Dimensionen	kg/m
IPE80	6,1	IPE270	36,8
IPE100	8,3	IPE300	43,0
IPE120	10,6	IPE330	50,0
IPE140	13,1	IPE360	58,2
IPE160	16,1	IPE400	67,6
IPE180	19,2	IPE450	79,1
IPE200	22,8	IPE500	92,4
IPE220	26,7	IPE550	108,0
IPE240	31,3	IPE600	124,3

BREITER I-TRÄGER, LEICHTE AUSFÜHRUNG, PARALLELE INNERE FLANSCHFLÄCHEN

Formstahl warmgewalzt S 235 JR, in HL

Dimensionen	kg/m	Dimensionen	kg/m
HEA100	17,0	HEA340	107,0
HEA120	20,3	HEA360	114,1
HEA140	25,2	HEA400	127,4
HEA160	31,0	HEA450	142,7
HEA180	36,2	HEA500	158,0
HEA200	43,1	HEA550	169,2
HEA220	51,5	HEA600	181,4
HEA240	61,5	HEA650	193,6
HEA260	69,5	HEA700	207,9
HEA280	77,9	HEA800	228,3
HEA300	90,0	HEA 900	258,0
HEA320	99,5	HEA1000	277,2

GÜTE S 355 JR AUF ANFRAGE.

GESÄGT, GESTRAHLT UND KONSERVIERT AUF ANFRAGE.

SÄGEZUSCHNITTE 90° UND GEHRUNGSSCHNITTE SIND EBENFALLS MÖGLICH.

FORMSTAHL 7

BREITER I-TRÄGER, PARALLELE INNERE FLANSCHFLÄCHEN

Formstahl warmgewalzt S 235 JR, in HL

Dimensionen	kg/m	Dimensionen	kg/m
HEB100	20,8	HEB340	136,6
HEB120	27,2	HEB360	144,7
HEB140	34,3	HEB400	158,0
HEB160	43,4	HEB450	174,3
HEB180	52,2	HEB500	190,6
HEB200	62,5	HEB550	202,8
HEB220	72,9	HEB600	216,1
HEB240	84,8	HEB700	245,6
HEB260	94,8	HEB800	269,0
HEB280	105,0	HEB900	298,0
HEB300	119,2	HEB1000	322,0
HEB320	129,4		

BREITER I-TRÄGER, VERSTÄRKTE AUSFÜHRUNG, PARALLELE INNERE FLANSCHFLÄCHEN

Formstahl warmgewalzt S 235 JR, in HL

Dimensionen	kg/m	Dimensionen	kg/m
HEM100	42,6	HEM340	254,0
HEM120	53,1	HEM360	256,0
HEM140	64,4	HEM400	260,9
HEM160	77,7	HEM450	270,0
HEM180	90,6	HEM500	275,2
HEM200	105,0	HEM550	283,3
HEM220	119,2	HEM600	292,0
HEM240	160,0	HEM650	300,0
HEM260	175,3	HEM700	309,0
HEM280	192,6	HEM800	341,0
HEM300	242,5	HEM1000	358,0
HEM320	251,0		

U-PROFIL, RUNDKANTIG

Formstahl warmgewalzt S 235 JR, in HL

Dimensionen	kg/m	Dimensionen	kg/m
UPN80	8,8	UPN240	33,8
UPN100	10,8	UPN260	38,6
UPN120	13,7	UPN280	42,6
UPN140	16,3	UPN300	47,1
UPN160	19,2	UPN320	60,6
UPN180	22,4	UPN350	61,8
UPN200	25,8	UPN380	64,3
UPN220	30,0	UPN400	73,2

GÜTE S 355 JR AUF ANFRAGE.

GESÄGT, GESTRAHLT UND KONSERVIERT AUF ANFRAGE.

SÄGEZUSCHNITTE 90° UND GEHRUNGSSCHNITTE SIND EBENFALLS MÖGLICH.



8 STABSTAHL

BANDSTAHL

warmgewalzt S 235 JR, in Handelslängen

Dimensionen in mm	kg/m
15 x 3	0,353
20 x 3	0,471
20 x 4	0,628
25 x 3	0,589
25 x 4	0,785
30 x 3	0,707
30 x 4	0,942
35 x 3	0,824
35 x 4	1,099
40 x 3	0,942
40 x 4	1,256
45 x 3	1,060
45 x 4	1,413

Dimensionen in mm	kg/m
50 x 3	1,178
50 x 4	1,570
60 x 3	1,413
60 x 4	1,884
70 x 3	1,649
70 x 4	2,198
80 x 3	1,884
80 x 4	2,512
90 x 3	2,120
90 x 4	2,826
100 x 3	2,355
100 x 4	3,140
120 x 4	3,768

STABSTAHL 9

FLACHSTAHL

warmgewalzt S 235 JR, in Handelslängen

Dimensionen in mm	kg/m
15 x 5	0,589
15 x 10	1,180
16 x 5	0,628
16 x 6	0,754
16 x 8	1,005
16 x 10	1,256
20 x 5	0,785
20 x 6	0,942
20 x 8	1,256
20 x 10	1,570
20 x 12	1,884
20 x 15	2,355
25 x 5	0,981
25 x 6	1,178
25 x 8	1,570
25 x 10	1,963
25 x 12	2,355
25 x 15	2,944
30 x 5	1,178
30 x 6	1,413
30 x 8	1,884
30 x 10	2,355
30 x 12	2,826
30 x 15	3,533
30 x 20	4,710
35 x 5	1,374
35 x 6	1,649
35 x 8	2,198
35 x 10	2,748
35 x 12	3,297
35 x 15	4,121
35 x 20	5,495
35 x 25	6,869
40 x 5	1,570
40 x 6	1,884
40 x 8	2,512
40 x 10	3,140
40 x 12	3,768
40 x 15	4,710
40 x 20	6,280

Dimensionen in mm	kg/m
40 x 25	7,850
40 x 30	9,420
45 x 5	1,766
45 x 6	2,120
45 x 8	2,826
45 x 10	3,533
45 x 12	4,239
45 x 15	5,299
45 x 20	7,065
45 x 25	8,831
45 x 30	10,600
50 x 5	1,963
50 x 6	2,355
50 x 8	3,140
50 x 10	3,925
50 x 12	4,710
50 x 15	5,888
50 x 20	7,850
50 x 25	9,813
50 x 30	11,775
50 x 40	15,700
55 x 10	4,320
100 x 5	3,925
100 x 6	4,710
100 x 8	6,280
100 x 10	7,850
100 x 12	9,420
100 x 15	11,775
100 x 20	15,700
100 x 25	19,625
100 x 30	23,550
100 x 40	31,500
100 x 50	39,250
100 x 60	47,100
110 x 6	5,181
110 x 8	6,908
110 x 10	8,635
110 x 12	10,362
110 x 15	12,953
110 x 20	17,270

Dimensionen in mm	kg/m
110 x 25	21,600
110 x 30	25,900
120 x 5	4,7100
120 x 6	6,000
120 x 8	7,536
120 x 10	9,420
120 x 12	11,304
120 x 15	14,130
120 x 20	18,840
120 x 25	23,550
120 x 30	28,260
120 x 40	37,680
120 x 50	47,100
120 x 60	56,500
130 x 8	8,164
130 x 10	10,205
130 x 12	12,246
130 x 15	15,308
130 x 20	20,410
130 x 25	25,500
140 x 6	6,594
140 x 8	8,792
140 x 10	10,990
140 x 12	13,188
140 x 15	16,485
140 x 20	21,980
140 x 25	27,475
140 x 30	32,970
140 x 40	43,960
140 x 50	55,000
150 x 5	5,888
150 x 6	7,065
150 x 8	9,420
150 x 10	11,775
150 x 12	14,130
150 x 15	17,663
150 x 20	23,550
150 x 25	29,438
150 x 30	35,325
150 x 40	47,100



FLACHSTAHL

warmgewalzt S 235 JR, in Handelslängen

Dimensionen in mm	kg/m
50 x 8	3,140
50 x 12	4,710
55 x 5	2,160
55 x 6	2,590
55 x 8	3,450
60 x 5	2,355
60 x 6	2,826
60 x 6	2,830
60 x 8	3,768
60 x 10	4,710
60 x 12	5,652
60 x 15	7,070
60 x 20	9,420
60 x 25	11,775
60 x 30	14,130
60 x 40	18,840
60 x 50	23,600
70 x 5	2,748
70 x 6	3,297
70 x 8	4,396
70 x 10	5,500
70 x 12	6,594
70 x 15	8,243
70 x 20	10,990
70 x 25	13,738
70 x 30	16,485
70 x 40	21,980
70 x 50	27,500

Dimensionen in mm	kg/m
80 x 10	6,280
80 x 12	7,536
80 x 15	9,420
80 x 20	12,560
80 x 25	15,700
80 x 30	18,840
80 x 40	25,120
80 x 50	31,400
80 x 60	37,680
80 x 5	3,1400
80 x 6	3,768
80 x 8	5,024
90 x 3	2,210
90 x 5	3,533
90 x 6	4,239
90 x 8	5,652
90 x 10	7,065
90 x 12	8,478
90 x 15	10,598
90 x 20	14,130
90 x 25	17,663
90 x 30	21,195
90 x 40	28,260
90 x 50	35,325
90 x 60	42,400
100 x 12	9,420
120 x 12	11,300
150 x 20	23,550

BREITFLACHSTAHL

warmgewalzt S 235 JR, in Handelslängen

Dimensionen in mm	kg/m
160 x 6	7,680
160 x 8	10,240
160 x 10	12,800
160 x 12	15,360
160 x 15	19,200
160 x 20	25,600
160 x 25	32,000
160 x 30	38,400
160 x 40	51,200
170 x 10	13,600
170 x 15	20,400
170 x 20	27,200
180 x 6	8,640
180 x 8	11,520
180 x 10	14,400
180 x 12	17,280
180 x 15	21,600
180 x 20	28,800
180 x 25	36,000
180 x 30	43,200
190 x 10	15,200
200 x 5	8,000
200 x 6	9,600
200 x 8	12,800
200 x 10	16,000
200 x 12	19,200
200 x 15	24,000
200 x 20	32,000
200 x 25	40,000
200 x 30	48,000
200 x 40	64,000
200 x 50	80,000
220 x 8	14,080
220 x 10	17,600
220 x 12	21,120
220 x 15	26,400
220 x 20	35,200
220 x 25	44,000
220 x 30	52,800
230 x 12	22,100

Dimensionen in mm	kg/m
200 x 20	32,000
240 x 10	19,200
240 x 12	23,000
240 x 15	28,800
240 x 20	38,400
240 x 25	48,000
240 x 30	57,600
250 x 8	16,000
250 x 10	20,000
250 x 12	24,000
250 x 15	30,000
250 x 20	40,000
250 x 25	50,000
250 x 30	60,000
250 x 40	80,000
260 x 10	20,800
260 x 12	25,000
260 x 15	31,200
280 x 10	21,980
280 x 12	26,900
280 x 15	33,600
280 x 20	44,800
300 x 8	19,200
300 x 10	24,000
300 x 12	28,800
300 x 15	36,000
300 x 20	48,000
300 x 25	60,000
300 x 30	72,000
350 x 10	28,000
350 x 12	33,000
350 x 15	42,000
350 x 20	56,000
400 x 8	25,600
400 x 10	32,000
400 x 12	38,400
400 x 15	48,000
400 x 20	64,000
400 x 25	80,000



RUNDSTAHL

warmgewalzt S 235 JR, in Handelslängen

Bezeichnung	kg/m
RD6	0,222
RD8	0,395
RD10	0,617
RD12	0,888
RD14	1,208
RD15	1,387
RD16	1,578
RD18	1,998

Bezeichnung	kg/m
RD20	2,466
RD22	2,984
RD24	3,551
RD25	3,853
RD27	4,495
RD28	4,834
RD30	5,549
RD35	7,553

Bezeichnung	kg/m
RD36	7,990
RD40	9,853
RD50	15,413
RD60	22,195
RD70	30,210
RD80	39,458

T-STAH

warmgewalzt S 235 JR, gerundete Kanten und Übergänge, in Handelslängen

Bezeichnung	kg/m
T20 x 3	0,88
T25 x 3,5	1,29
T30 x 4	1,77
T35 x 4,5	2,33
T40 x 5	2,96
T50 x 6	4,44
T60 x 7	6,23

Bezeichnung	kg/m
T70 x 8	8,32
T80 x 9	10,70
T90 x 10	13,40
T100 x 11	16,40
T120 x 13	23,20
T140 x 15	31,30

U-STAH

warmgewalzt S 235 JR, rundkantig, in Handelslängen

Dimensionen in mm	kg/m
30 x 15 x 4,0	1,70
30 x 33 x 5,0	4,20
40 x 20 x 5,0	2,80
40 x 35 x 5,0	4,80

Dimensionen in mm	kg/m
50 x 25 x 5,0	3,80
50 x 38 x 5,0	5,50
60 x 30 x 6,0	5,00
65 x 42 x 5,5	7,00

VIERKANTSTAHL

warmgewalzt S 235 JR, in Handelslängen

Bezeichnung	kg/m
VK6	0,283
VK8	0,502
VK10	0,785
VK12	1,130
VK13	1,330
VK14	1,539
VK15	1,766

Bezeichnung	kg/m
VK16	2,010
VK20	3,140
VK25	4,906
VK30	7,065
VK35	9,616
VK40	12,560
VK45	15,896

Bezeichnung	kg/m
VK50	19,625
VK60	28,260
VK70	38,465
VK80	50,240
VK90	63,585
VK100	78,500
VK120	113,000

WINKELSTAHL

warmgewalzt S 235 JR, rundkantig, gleichschenklig, in Handelslängen

Dimensionen in mm	kg/m
20 x 3	0,88
20 x 4	1,14
25 x 3	1,12
25 x 4	1,45
25 x 5	1,77
30 x 3	1,36
30 x 4	1,78
30 x 5	2,18
35 x 4	2,09
35 x 5	2,57
40 x 4	2,42
40 x 5	2,97
40 x 6	3,52
45 x 5	3,38
50 x 4	3,06
50 x 5	3,77

Dimensionen in mm	kg/m
50 x 6	4,47
50 x 7	5,15
50 x 8	5,82
55 x 6	4,95
60 x 5	4,57
60 x 6	5,42
60 x 8	7,09
60 x 10	8,69
65 x 7	6,83
70 x 7	7,38
70 x 9	9,34
75 x 8	9,03
80 x 6	7,34
80 x 8	9,63
80 x 10	11,90
90 x 9	12,20

Dimensionen in mm	kg/m
100 x 8	12,20
100 x 10	15,10
100 x 12	17,80
120 x 10	18,20
120 x 12	21,60
120 x 15	26,60
130 x 12	23,60
140 x 13	27,50
150 x 10	23,00
150 x 12	27,30
150 x 15	34,00
160 x 15	36,20
160 x 17	40,70
180 x 16	43,50
200 x 16	48,50
200 x 20	59,90

WINKELSTAHL

warmgewalzt S 235 JR, rundkantig, ungleichschenklig, in Handelslängen

Dimensionen in mm	kg/m
30 x 20 x 3	1,12
40 x 20 x 3	1,35
40 x 20 x 4	1,77
45 x 30 x 4	2,25
45 x 30 x 5	2,77
50 x 30 x 5	2,96
50 x 40 x 4	2,71
50 x 40 x 5	3,35
60 x 30 x 5	3,36
60 x 30 x 6	3,99
60 x 40 x 5	3,76
60 x 40 x 6	4,46
60 x 40 x 7	5,14
65 x 50 x 5	4,35
65 x 50 x 7	5,97
70 x 50 x 6	5,41
75 x 50 x 5	4,74
75 x 50 x 7	6,51

Dimensionen in mm	kg/m
80 x 40 x 6	5,41
80 x 40 x 8	7,07
80 x 60 x 7	7,36
80 x 65 x 6	6,60
80 x 65 x 8	8,66
80 x 65 x 10	10,7
90 x 60 x 6	6,82
90 x 60 x 8	8,96
100 x 50 x 6	6,84
100 x 50 x 8	8,97
100 x 50 x 10	11,10
100 x 65 x 7	8,77
100 x 65 x 9	11,10
100 x 65 x 11	13,40
100 x 75 x 7	9,32
100 x 75 x 9	11,80
120 x 80 x 8	12,20
120 x 80 x 10	15,00

Dimensionen in mm	kg/m
120 x 80 x 12	17,80
130 x 65 x 8	11,90
130 x 65 x 10	14,60
130 x 65 x 12	17,30
150 x 75 x 9	15,30
150 x 90 x 10	18,20
150 x 90 x 12	21,60
150 x 75 x 11	18,60
150 x 100 x 10	19,00
150 x 100 x 12	22,60
160 x 80 x 10	18,20
180 x 90 x 10	20,60
200 x 100 x 10	23,00
200 x 100 x 12	27,30
200 x 100 x 14	31,60
250 x 90 x 10	26,10
250 x 90 x 12	31,10



Z-PROFILE, RUNDKANTIG

S 235 JR



Profil-Nr.	Dimensionen in mm	kg/m	Artikel-Nr.
01.150.0	30 x 38 x 38 x 4,5 x 4,0	3,39	904500134
01.154.0	40 x 40 x 40 x 5,0 x 4,5	4,25	904500138
01.156.0	50 x 43 x 43 x 5,5 x 5,0	5,30	904500136
01.159.0	60 x 45 x 45 x 6,0 x 5,0	6,20	904500143
71.234.0	80 x 50 x 50 x 7,0 x 6,0	8,70	904500146
74.011.0	100 x 55 x 55 x 8,0 x 6,0	11,40	904500141
70.007.0	120 x 60 x 60 x 9,0 x 7,0	14,30	904500152
70.008.0	140 x 65 x 65 x 10,0 x 8,0	18,00	904500149
70.009.0	160 x 70 x 70 x 11,0 x 8,5	21,60	904500132

BODENBELAG-WINKELPROFILE

S 235 JR

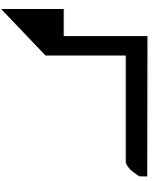

Profil-Nr.	Dimensionen in mm	kg/m	Artikel-Nr.
65.006.0	16 x 24 x 40 x 10 x 5	3,20	904500001
65.007.0	20 x 30 x 50 x 10 x 5	4,12	904500002
65.008.0	20 x 30 x 50 x 12 x 7	4,48	904500003
65.009.0	20 x 30 x 50 x 14 x 7	5,50	904500004
65.010.0	20 x 30 x 50 x 17 x 10	5,70	904500000

WINKELÄHNLICHES PROFIL

S 235 JR



Profil-Nr.	Dimensionen in mm	kg/m	Artikel-Nr.
00.452.0	53 x 16 x 10 x 8	4,00	904500007

T-PROFILE, RUNDKANTIG, BREITFÜSSIG

S 235 JR



Profil-Nr.	Dimensionen in mm	kg/m	Artikel-Nr.
00.689.0	40 x 20 x 4,5 (TB 20)	2,00	904500099
00.706.0	50 x 25 x 5,0 (TB 25)	2,80	904500103
00.726.0	60 x 30 x 5,5 (TB 30)	3,64	904500101
00.859.0	70 x 35 x 6,0 (TB 35)	4,75	904500105
00.740.0	80 x 40 x 7,0 (TB 40)	6,21	904500107
71.035.0	100 x 50 x 8,5 (TB 50)	9,42	904500109
70.011.0	120 x 60 x 10,0 (TB 60)	13,40	904500097

T-PROFILE, SCHARFKANTIG, BREITFÜSSIG

S 235 JR



Profil-Nr.	Dimensionen in mm	kg/m	Artikel-Nr.
03.984.0	40 x 20 x 3,0	1,36	904500117

TREPPENSCHUTZSCHIENE

S 235 JR



Profil-Nr.	Bezeichnung	kg/m	Artikel-Nr.
62.294.0	TS562294 35 mm	1,75	904500018

HALBRUNDPROFILE

S 235 JR



Profil-Nr.	Bezeichnung	kg/m	Artikel-Nr.
02.013.0	HRP 16 x 8,0	0,79	904500043
02.017.0	HRP 20 x 10,0	1,22	904500039
02.027.0	HRP 30 x 15,0	2,75	904500040
02.037.0	HRP 40 x 20,0	4,92	904500045
02.042.0	HRP 50 x 25,0	7,65	904500046
02.045.0	HRP 60 x 30,0	11,00	904500041
60.101.0	HRP 75 x 37,5	17,30	904500042

FLACHHALBRUNDPROFILE

S 235 JR



Profil-Nr.	Bezeichnung	kg/m	Artikel-Nr.
02.184.0	FHR 30 x 10	1,73	904500036
02.238.0	FHR 40 x 10	2,22	904500037
02.268.0	FHR 50 x 13	3,60	904500038

HANDLEISTENPROFILE

S 235 JR



Profil-Nr.	Dimensionen in mm	kg/m	Artikel-Nr.
03.091.0	40 x 18 x 8	3,30	904500030
09.131.0	50 x 22,5 x 10	5,30	904500014

GITTERPROFILE (HESPENPROFILE)

S 235 JR



Profil-Nr.	Dimensionen in mm	kg/m	Artikel-Nr.
01.272.0	30 x 8 x 4 x 3,5	1,24	904900024
05.022.0	40 x 13 x 5 x 7,0	2,25	904900028



STALLROSTPROFILE

S 235 JR, mit 4 abgerundeten Kanten, Flachoval

Bezeichnung	kg/m	Artikel-Nr.
SRP 24 x 11	1,85	904500088
SRP 32 x 18	3,95	904500090
SRP 40 x 10	2,90	904500086

MONTAGESCHIENEN

S 235

Bezeichnung	kg/m	Artikel-Nr.
MSW 40 x 22	2,20	904500020
MSW 50 x 30	3,40	904500026
MSW 52 x 34 x 4	5,05	904500022

HUBSCHIENENPROFILE

18MnNb

Bezeichnung und Länge	kg/m	Artikel-Nr.
HS2911 18,1 m	17,82	904500051
HS2912	31,17	904500050
HS3018	19,40	904500048
HS3019	25,30	904500049
HS3394	27,08	904500069

WULSTFLACHSTÄHLE, WARMGEWALZT

S 235 JR

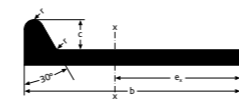

Dimensionen in mm	kg/m
60 x 4	2,86
60 x 5	3,34
60 x 6	3,82
80 x 5	4,25
80 x 6	4,88
100 x 7	6,86
100 x 8	7,65
120 x 6	7,32
120 x 7	8,26
120 x 8	9,20
140 x 7	9,75
140 x 8	10,85
140 x 10	13,05
160 x 7	11,46
160 x 8	12,72
160 x 9	13,97
160 x 11	16,49
180 x 8	14,80
180 x 9	16,22
180 x 10	17,63
180 x 11	19,04
200 x 9	18,57
200 x 10	20,14
200 x 11	21,71
200 x 12	23,28
220 x 10	22,77
220 x 11	24,50
220 x 12	26,22
240 x 10	25,50

Dimensionen in mm	kg/m
240 x 11	27,39
240 x 12	29,27
260 x 10	28,35
260 x 11	30,39
260 x 12	32,43
280 x 11	33,50
280 x 12	35,70
280 x 13	37,90
300 x 11	36,70
300 x 12	39,09
300 x 13	41,44
320 x 12	42,60
320 x 13	45,09
320 x 14	47,60
340 x 12	46,20
340 x 13	48,86
340 x 14	51,50
370 x 13	54,70
370 x 14	57,60
370 x 15	60,50
400 x 14	63,96
400 x 15	67,10
400 x 16	70,20
430 x 14	70,60
430 x 15	73,90
430 x 17	80,70
430 x 19	87,40
430 x 20	90,80



U-BAUSTAHLPROFILE
S 235 JR



Dimensionen in mm	kg/m	Artikel-Nr.
30 x 30 x 3	1,87	904900317
36 x 36 x 3	2,37	904900319
40 x 20 x 3	1,67	904900322
40 x 25 x 3	1,88	904900324
40 x 35 x 4	3,02	904900326
40 x 40 x 3	2,47	904900328
40 x 40 x 4	3,55	904900330
46 x 45 x 3	2,95	904900337
50 x 30 x 3	2,36	904900341
50 x 40 x 4	3,67	904900345
50 x 50 x 3	3,26	904900347
50 x 50 x 4	4,38	904900349
54 x 45 x 4	4,12	904900351
60 x 30 x 3	2,59	904900353
60 x 40 x 3	3,10	904900355
60 x 40 x 4	3,96	904900357
62 x 45 x 4	4,36	904900359
65 x 40 x 5	5,05	904900361
65 x 50 x 5	5,84	904900363
70 x 40 x 3	3,82	904900365
70 x 50 x 4	4,93	904900367
80 x 40 x 3	3,54	904900369

Dimensionen in mm	kg/m	Artikel-Nr.
80 x 40 x 4	4,54	904900371
80 x 45 x 5	6,04	904900373
80 x 50 x 4	5,32	904900377
80 x 50 x 5	6,42	904900379
80 x 50 x 6	7,56	904900383
80 x 54 x 4	5,41	904900489
80 x 54 x 5	6,61	904900488
80 x 70 x 5	8,00	904900387
90 x 50 x 4	5,44	904900389
90 x 50 x 5	6,80	904900391
90 x 54 x 5	7,00	904900487
100 x 50 x 4	5,87	904900396
100 x 50 x 5	7,22	904900400
100 x 50 x 6	8,50	904900406
100 x 70 x 6	10,30	904900410
120 x 50 x 4	6,51	904900412
120 x 60 x 4	7,14	904900414
120 x 60 x 6	10,40	904900416
140 x 60 x 4	7,68	904900420
140 x 60 x 6	11,30	904900422
160 x 65 x 6	12,75	904900424
200 x 80 x 6	16,00	904900428

BORDWAND-U-PROFILE
S 235 JR



Dimensionen in mm	kg/m	Artikel-Nr.
20 x 20 x 1,5	0,67	904900295
23 x 23 x 1,5	0,77	904900299
25 x 25 x 1,5	0,83	904900303
28 x 28 x 1,5	0,94	904900307
30 x 30 x 1,5	1,01	904900311
30 x 30 x 2,0	1,34	904900315

C-PROFILE (LEICHTBAUPROFILE), KALTPROFILIERT



Dimensionen in mm	kg/m	Artikel-Nr.
60 x 40 x 15 x 3,0	3,50	904900043
80 x 40 x 15 x 3,0	4,19	904900045
100 x 40 x 15 x 3,0	4,66	904900029
120 x 40 x 15 x 3,0	5,13	904900031
140 x 40 x 15 x 3,0	5,60	904900033
160 x 40 x 15 x 3,0	6,08	904900035
180 x 40 x 15 x 3,0	6,55	904900037
200 x 40 x 15 x 3,0	7,02	904900039



20 **SPEZIALPROFILE, KALTPROFILIERT**

WINKELPROFILE, SCHARFKANTIG, GLEICHSCHENKLIG

S 235 JR



Profil-Nr.	Dimensionen in mm	kg/m	Artikel-Nr.
88.548.0	10 x 10 x 2	0,28	904900109
87.540.0	15 x 15 x 2	0,49	904900111
81.502.0	15 x 15 x 3	0,62	904900113
80.518.0	20 x 20 x 2	0,59	904900115
00.115.0	20 x 20 x 3	0,86	904900756
00.115.0	20 x 20 x 4	1,12	904900758
80.519.0	25 x 25 x 2	0,75	904900117
80.576.0	25 x 25 x 3	1,12	904900760
00.119.0	25 x 25 x 4	1,45	904900762
80.520.0	30 x 30 x 2	1,08	904900119
80.577.0	30 x 30 x 3	1,32	904900764
00.121.0	30 x 30 x 4	1,76	904900766
80.540.0	35 x 35 x 3	1,58	904900768
00.123.0	35 x 35 x 4	2,07	904900770
82.523.0	40 x 40 x 3	1,81	904900772
00.124.0	40 x 40 x 4	2,39	904900774
00.124.0	40 x 40 x 5	2,91	904900776
00.125.0	45 x 45 x 5	3,32	904900121
80.578.0	50 x 50 x 3	2,25	904900123
80.579.0	50 x 50 x 4	3,01	904900125
00.126.0	50 x 50 x 5	3,73	904900127
85.511.0	60 x 60 x 3	2,81	904900129
88.543.0	60 x 60 x 4	3,62	904900131
00.129.0	60 x 60 x 5	4,43	904900133

SPEZIALPROFILE, KALTPROFILIERT 21

WINKELPROFILE, SCHARFKANTIG, UNGLEICHSCHENKLIG

S 235 JR



Profil-Nr.	Dimensionen in mm	kg/m	Artikel-Nr.
89.550.0	20 x 10 x 2	0,45	904900135
89.511.0	20 x 10 x 3	0,64	904900137
89.514.0	20 x 14 x 3	0,73	904900139
79.154.0	25 x 15 x 3	0,87	904900141
79.147.0	30 x 16 x 3	1,02	904900143
79.148.0	30 x 16 x 4	1,33	904900145
80.521.0	30 x 20 x 3	1,11	904900778
80.549.0	30 x 20 x 4	1,43	904900780
79.042.0	35 x 20 x 3	1,16	904900149
80.511.0	35 x 20 x 4	1,70	904900151
83.503.0	40 x 20 x 3	1,34	904900782
81.511.0	40 x 20 x 4	1,77	904900784
80.522.0	40 x 25 x 3	1,50	904900153
81.524.0	40 x 25 x 4	1,75	904900786
80.523.0	40 x 30 x 3	1,60	904900155
80.531.0	40 x 30 x 4	2,08	904900157
80.524.0	45 x 30 x 3	1,77	904900788
80.573.0	45 x 30 x 4	2,23	904900790
00.203.0	45 x 30 x 5	2,71	904900792
80.525.0	50 x 25 x 3	1,71	904900159
80.532.0	50 x 25 x 4	2,25	904900161
80.574.0	50 x 30 x 4	2,43	904900794
79.055.0	50 x 35 x 4	2,54	904900163
87.539.0	50 x 40 x 4	2,61	904900165
79.070.0	60 x 30 x 3	2,05	904900167
79.071.0	60 x 30 x 4	2,81	904900169
80.559.0	60 x 40 x 4	3,02	904900171
79.082.0	80 x 40 x 4	3,65	904900173



U-PROFILE, SCHARFKANTIG

S 235 JR



Profil-Nr.	Dimensionen in mm	kg/m	Artikel-Nr.
01.387.0	20 x 10 x 3,00	0,80	904900066
79.116.0	20 x 15 x 2,50	0,90	904900175
72.183.0	24 x 15 x 2,00	0,79	904900177
79.072.0	30 x 15 x 3,00	1,28	904900179
80.535.0	30 x 15 x 4,00	1,74	904900074
79.056.0	30 x 20 x 4,00	1,98	904900181
80.527.0	30 x 25 x 4,00	2,27	904900183
79.073.0	35 x 25 x 4,00	2,43	904900185
79.068.0	36 x 24 x 3,00	1,85	904900187
79.117.0	40 x 24 x 3,25	2,08	904900189
05.040.0	41 x 20 x 5,00	2,79	904900191
79.032.0	45 x 27 x 3,25	2,38	904900193
79.150.0	50 x 25 x 3,00	2,22	904900195
79.155.0	50 x 30 x 3,25	2,65	904900196
80.536.0	50 x 30 x 4,00	3,21	904900198
82.577.0	60 x 30 x 3,00	2,72	904900200
79.074.0	60 x 30 x 4,00	3,55	904900202
89.537.0	60 x 38 x 4,00	4,05	904900204
79.046.0	70 x 25 x 3,00	2,69	904900206
89.546.0	70 x 45 x 4,00	5,50	904900208
89.531.0	80 x 25 x 3,50	3,40	904900210
89.547.0	100 x 40 x 4,00	5,32	904900076
81.525.0	140 x 50 x 4,00	7,28	904900212

ROLLADEN-U-PROFILE, SCHARFKANTIG

S 235 JR



Profil-Nr.	Dimensionen in mm	kg/m	Artikel-Nr.
68.174.0	12 x 12,5 x 2,0	0,52	904900214
68.184.0	12 x 20,0 x 1,5	0,54	904900216
68.150.0	15 x 15,0 x 1,5	0,49	904900218
68.176.0	15 x 20,0 x 1,5	0,60	904900220
69.099.0	20 x 20,0 x 2,0	0,88	904900222
80.541.0	20 x 20,0 x 2,5	1,08	904900226
69.100.0	25 x 25,0 x 2,0	1,12	904900224
79.118.0	25 x 25,0 x 2,5	1,38	904900228
79.027.0	25 x 25,0 x 4,0	2,10	904900230
79.024.0	28 x 40,0 x 2,75	2,23	904900232
69.103.0	30 x 30,0 x 2,0	1,35	904900236
79.075.0	30 x 30,0 x 2,5	1,67	904900238
79.119.0	30 x 30,0 x 2,8	1,85	904900240
79.076.0	33 x 33,0 x 2,7	2,03	904900242
79.025.0	33 x 50,0 x 3,7	3,75	904900244
79.026.0	36 x 36,0 x 3,0	2,40	904900248
72.185.0	40 x 40,0 x 2,0	1,82	904900250
79.120.0	40 x 40,0 x 3,0	2,69	904900252
80.526.0	40 x 40,0 x 3,5	3,12	904900254
79.031.0	50 x 50,0 x 4,0	4,46	904900256
71.088.0	60 x 55,0 x 5,0	6,29	904900258

Z-PROFILE, SCHARFKANTIG

S 235 JR



Profil-Nr.	Dimensionen in mm	kg/m	Artikel-Nr.
79.051.0	9 x 20 x 13 x 3,0 x 3,0	0,84	904900087
79.098.0	16 x 25 x 25 x 3,5 x 3,5	1,62	904900085
79.053.0	20 x 18 x 13 x 4,0 x 4,0	1,35	904900097
80.510.0	25 x 16 x 16 x 3,0 x 3,0	1,20	904900098
79.052.0	30 x 35 x 17 x 4,0 x 4,0	2,32	904900101
80.542.0	35 x 30 x 18 x 3,0 x 3,0	1,82	904900091
90.501.0	40 x 35 x 25 x 3,0 x 3,0	2,22	904900095
89.528.0	40 x 35 x 25 x 4,0 x 4,0	2,90	904900103
89.539.0	48 x 50 x 25 x 4,0 x 4,0	3,65	904900105
79.054.0	50 x 25 x 18 x 3,0 x 3,0	2,05	904900093
89.540.0	54 x 50 x 25 x 4,0 x 4,0	3,81	904900107



BRÜCKENHANDLAUF, OFFEN

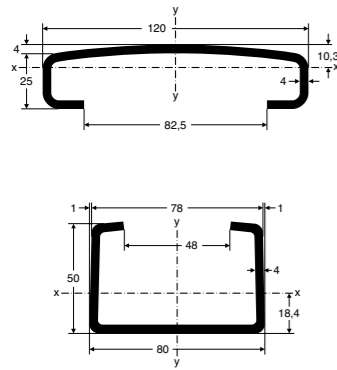

Profil-Nr.	Bezeichnung	Statische Werte	theor. Gewicht ca. kg/m	Artikel-Nr.
70.030.1	Obergurt	F cm 7,36 Jx cm 6,16 Wx Cm 3,29 Jy cm 1,27 Wy cm 21,20	5,78	904900821
72.007.1	Untergurt	F cm 7,35 Jx cm 22,10 Wx Cm 7,00 Jy cm 69,10 Wy cm 17,30	5,77	904900823

BRÜCKENHANDLAUF-VERBINDER

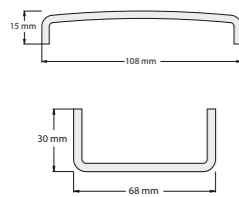

Profil-Nr.		Artikel-Nr.
14.501	passend zu Obergurt KP 70.030 Länge 3.000 mm	940016961
14.502	passend zu Untergurt KP 72.007 Länge 3.000 mm	940016960

BRÜCKENHANDLAUF, GESCHLOSSEN

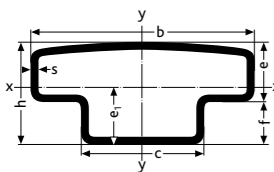

Profil-Nr.	Dimensionen in mm						theor. Gewicht ca. kg/m	Artikel-Nr.
	b	b ₁	h	h ₁	s	e		
HOP 39.036	120	55	65	4	32	23	10	HL 6M 904901744 HL 12M 904901743
HOP 39.102	80	46	45	4	34	12	7	HL 6M 940001785 HL 12M 940001786

MARKISEN-UND TRENNWANDPROFILE

S 235 JR



Profil-Nr.	Dimensionen in mm	kg/m	Artikel-Nr.
55.166.1	27 x 12 x 7,5 x 2,5	1,00	904900068
52.074.0	30 x 30 x 10,0 x 2,0	1,58	904900070

WELLGITTER U-PROFILE, KALTPROFILIERT

S 235 JR

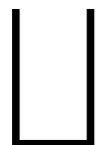

Dimensionen in mm	kg/m	Artikel-Nr.
10 x 25 x 1,5	0,65	904900292
10 x 30 x 2,0	0,98	904900293

SPROSSENROHR, GESCHW., KHP25 X 1,5SPR

Dimensionen in mm	kg/m	Artikel-Nr.
25 x 1,5	1,10	940002195

RADREIFENSTAHL

S 235 JR



Profil-Nr.	Dimensionen in mm	kg/m	Artikel-Nr.
58.170.0	50 x 16 x 3,5	2,35	904900083

STAHLSCHUTZPLANKEN UND ZUBEHÖR, VERZINKT

Bezeichnung	kg/m	Artikel-Nr.
Leitplanke Profil B, in HL 4300/4000	44,00	940106873
Kopfstück Profil B	9,00	940106877
Winkelstück Profil B – innen	12,00	940106874
Winkelstück Profil B – außen	12,00	940106875
Pfosten IPE 100 mit Fußplatte 250/300/10mm, Höhe 700mm	12,00	940106879
Stützbügel	1,00	940106876
Decklasche	0,10	940106878
Verbindungsschraube M16x25	0,04	940106881
Befestigungsschraube M10x45	0,04	940106880

BITTE FRAGEN SIE GERN AUCH HIER NICHT AUFGEFÜHRTE PROFILE AN!



ANSCHLAGPROFILE
S 235 JR

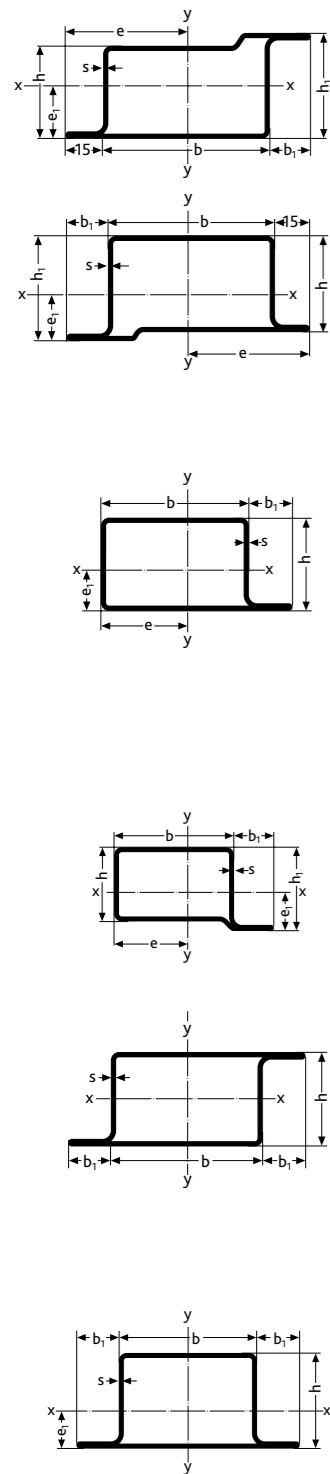

Profil-Nr.		Dimensionen in mm							Artikel-Nr.
		b	b ₁	h	h ₁	s	e	e ₁	
WP3450/15ZK	HoP 54238	50	15,0	34	38	2	4,10	1,82	907200022
WP4070/17ZK	HoP 53202	70	17,5	40	44	2	5,18	2,10	907200011
WP3435/15TK	HoP 57179	35	15,0	34	38	2	3,29	1,53	907200027
WP3450/15TK	HoP 54237	50	15,0	34	38	2	4,10	1,60	907200021
WP4070/17TK	HoP 53203	70	17,5	40	44	2	5,18	1,96	907200012
WP3420/15L	HoP 54235	20	15,0	34		2	1,28	1,32	907200020
WP4020/15L	HoP 54232	20	15,0	40		2	1,28	1,59	907200018
WP5020/20L	HoP 59065	20	22,0	50		2	1,52	1,92	907200032
WP3425/15L	HoP 54234	25	15,0	34		2	1,69	1,38	907200019
WP3435/15L	HoP 53100	35	15,0	34		2	2,20	1,40	907200007
WP4040/15L	HoP 53040	40	15,0	40		2	2,40	1,70	907200006
WP5040/20L	HoP 68137	40	22,0	50		2	2,62	2,04	907200046
WP3450/15L	HoP 57184	50	15,0	34		2	3,00	1,36	907200029
WP3455/15L	HoP 53101	55	15,0	34		2	3,20	1,50	907200008
WP4060/15L	HoP 62091	60	15,0	40		2	3,40	1,76	907200038
WP4070/15L	HoP 59066	70	15,0	40		2	3,80	1,78	907200033
WP3410/15L	HoP 65111	100	15,0	34		2	5,60	1,55	907200040
WP3435/15LK	HoP 57180	35	15	34	38	2	2,240	1,71	907201564
WP3455/15LK	HoP 63011	55	15	34	38	2	3,400	1,75	907200039
WP4060/15LK	HoP 66132	60	15	40	44	2	3,540	2,02	907200041
WP3420/15Z	HoP 61025	20	15	34		2	3,080		907200036
WP5020/20Z	HoP 59063	20	20	50		2	4,230		907200030
WP3435/15Z	HoP 54138	35	15	34		2	3,800		907200014
WP4040/15Z	HoP 66168	40	15	40		2	4,240		907200042
WP5040/20Z	HoP 68136	40	22	50		2	5,100		907200045
WP3450/15Z	HoP 61023	50	15	34		2	4,300		907200034
WP3455/15Z	HoP 54233	55	15	34		2	4,490		
WP3420/15T	HoP 57022	20	15	34		2	1,100		907200023
WP4020/15T	HoP 53209	20	15	40		2	1,380		907200013
WP5020/20T	HoP 59064	20	22	50		2	1,600		907200031
WP3435/15T	HoP 54160	35	15	34		2	1,225		907200015
WP4040/15T	HoP 53162	40	15	40		2	1,480		907200009
WP5040/20T	HoP 68135	40	22	50		2	1,730		907200043
WP3450/15T	HoP 61024	50	15	34		2	1,290		907201567
WP3455/15T	HoP 53163	55	15	34		2	1,330		907200010

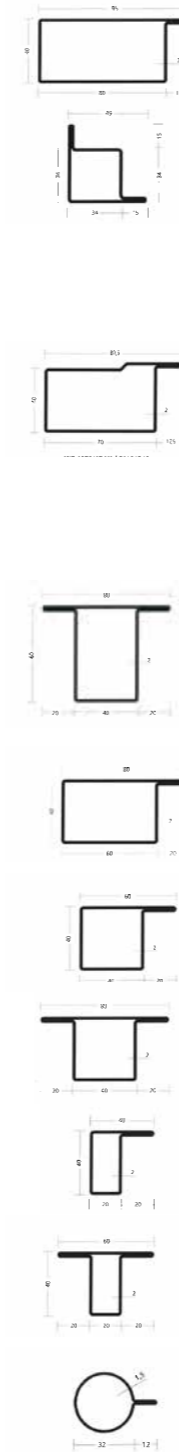

Profil-Nr.		Dimensionen in mm							Artikel-Nr.
		b	b ₁	h	h ₁	s	e	e ₁	
WP4080/15L		80	15	40		2	6,55	9,89	907201564
WP3434/15S		34	15	34	49	2	2,91	2,91	907200024
WP3434/15S		34	15	34	49	2	2,92	2,92	907200025
WP4070/17LK		70	17,5	40	44,5	2	6,29	8,47	907200052
WP6040/20L		40	20	60		2	6,76	4,55	907201565
WP6040/20T		40	20	60		2	7,22	6,16	907201566
WP4060/20L		60	20	40		2	5,17	6,71	940002792
WP4040/20L		40	20	40		2	3,78	3,77	907201567
WP4040/20T		40	20	40		2	3,93	5,34	907201568
WP4020/20L		20	20	40		2	2,40	1,56	940001847
WP4020/20T		20	20	40		2	2,55	2,66	940001846
WP32/12R		32				1,5	1,05	1,27	907200037

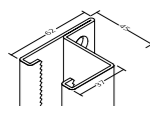

ZAHNSCHIENE AUSSEN

WP-Artikel-Nr.	Lieferlänge/VE in m	theor. Gewicht ca. kg/m	Artikel-Nr.
W 03-01	4.500 mm/90 m	3,05	904900842

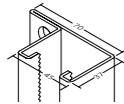

ZAHNSCHIENE INNEN

WP-Artikel-Nr.	Lieferlänge/VE in m	theor. Gewicht ca. kg/m	Artikel-Nr.
W 03-02	4.500 mm/90 m	3,05	904900844

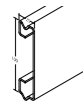

LAMELLE

WP-Artikel-Nr.	Lieferlänge/VE in m	theor. Gewicht ca. kg/m	Artikel-Nr.
W 03-03	4.500 mm/162 m	3,05	904900846

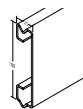

VERSTÄRKUNG

WP-Artikel-Nr.	Lieferlänge/VE in m	theor. Gewicht ca. kg/m	Artikel-Nr.
W 03-04	4.500 mm/180 m	2,60	904900848

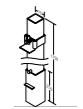

MITTELSTÜTZE

WP-Artikel-Nr.	Lieferlänge/VE in m	theor. Gewicht ca. kg/St.	Artikel-Nr.
W 09-06	1.750 mm	18	904900923

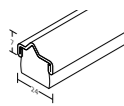

FUSSDICHTUNGS-SCHIENE INKL.DICHTUNG FARBLOS

WP-Artikel-Nr.	Lieferlänge/VE in m	theor. Gewicht ca. kg/m	Artikel-Nr.
W 08-06	4.500 mm/45 m	0,51	904901310



KLEMMSTÜCK + SCHRAUBEN + SCHLÜSSEL

WP-Artikel-Nr.	Lieferlänge/VE in m	theor. Gewicht ca. kg/m	Artikel-Nr.
W 03-11Z	2 Stück/VE	0,80	904900856



ZAHNSCHIENENDICHTUNG

WP-Artikel-Nr.	Lieferlänge/VE in m	theor. Gewicht ca. kg/m	Artikel-Nr.
W 13-01Z	25 m/Rolle	0,3	940013811



LAMELLENDICHTUNG

WP-Artikel-Nr.	Lieferlänge/VE in m	theor. Gewicht ca. kg/m	Artikel-Nr.
W 03-10Z	200 m/Rolle	0,05	904900853



ABSCHLUSSDICHTUNG/TACKBAND

WP-Artikel-Nr.	Lieferlänge/VE in m	theor. Gewicht ca. kg/m	Artikel-Nr.
W 11-01Z	35 mm x 10 m Rolle	0,70	940007022

Klöckner & Co Deutschland

Zentrale

Am Silberpalais 1
D-47057 Duisburg

Telefon +49 (0) 203 307-0

Telefax +49 (0) 203 307-5245

E-Mail kontakt@kloeckner.com

www.kloecknerdeutschland.de

Ihr Ansprechpartner:



Technische Änderungen und Irrtum vorbehalten.
Gestaltung: www.optimat.de

